

YAMAHA  
ROBOT  
LINEUP CATALOG



# YAMAHA ROBOT

## History and approach

### 30 years of proven reliability.

YAMAHA's robot development started as it was introduced in our motorcycle production line more than 30 years ago.



Since then, YAMAHA's industrial robots have supported production equipment in a wide variety of industries, such as assembly of electronic products, transfer of in-vehicle components, and manufacture of large-scale LCD panels.

Over the years YAMAHA has striven to develop and improve the market and this is a testament to YAMAHA's reliability.

### Technical development based on the originally developed technologies and focusing on the needs of the market

"Motor control technology" absolutely necessary for precise and high-speed operation "Controller development technology" is based on the highest evaluation standards and Signal processing technology allowing stable operation even under extreme environmental conditions.



Rigidity, durability, and operability are features of YAMAHA's products base on "Coretechnologies\*\*".

\*Control boards, linear motors, and linear scales (position detectors), etc.

### Evaluation system provides high reliability

YAMAHA continues to evaluate technology to assure product reliability.

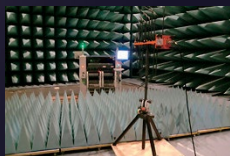

In the product development phase, the evaluation test at "anechoic chamber"\* (YAMAHA's equipment) was developed to ensure the high reliability and quality.

\*Anechoic chamber: This equipment is intended to synthetically develop the EMC (Electro-Magnetic Compatibility) technologies for YAMAHA Group products and to share the developed technologies. This equipment can evaluate the compliance with each country's regulation in conformity with the international standards.

### YAMAHA quality ensuring safety

Manufacturing, sales, and technology integrated system is utilized at its maximum level to establish a system that consistently performs a series of processes: inspection → manufacture → assembly → inspection → shipping. This can provide the customers with high quality, low price, and short delivery time.

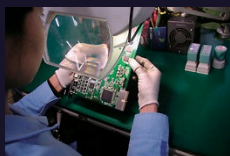

Key components are manufactured through in-house processing and machining. YAMAHA as a robot manufacturer builds the components to the highest quality level.

Furthermore, the quality control based on the severe standards achieves the craftsmanship with high quality.

# Robonity

## Motorless Single Axis Actuator

Quick selection table ▶▶ P18



### Basic model

## LBAS

Newly designed integrated guide rail/frame structure.

Improved moment load capacity in compact frame size.

Designed to accommodate motors from most leading manufacturers.

High Rigidity

Compact

Low Cost

Maximum payload	2 kg to 100 kg
Maximum speed	133 to 1,333 mm/sec
Stroke	50 to 1,100 mm

### Advanced model

## LGXS

Higher efficiency, accuracy, and reliability from ground ball screw.

Ideal for base axis of multi-axis configuration.

High Precision Accuracy Class C5

High Durability

Clean specification as a standard feature

Maximum payload	2 kg to 160 kg
Maximum speed	300 to 2,400 mm/sec
Stroke	50 to 1,450 mm

# Series



## High Rigidity

Moment rigidity is increased approximately three times from current models.

	Existing product T6L	<b>LBAS05</b>	Existing product T9H	<b>LBAS08</b>
MY	35	<b>59</b>	86	<b>221</b>
MP	40	<b>63</b>	133	<b>309</b>
MR	50	<b>103</b>	117	<b>343</b>
		(N · m)		(N · m)

## High Precision

Straightness (running parallelism):  $\pm 0.02/800$  mm

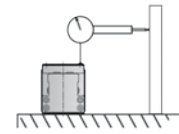

## Motor orientation is changeable with Right Angle Attachment Kit.

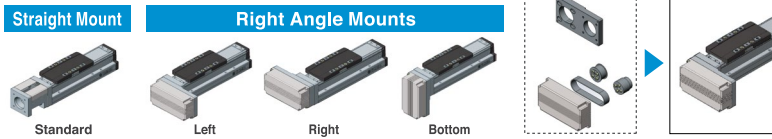

## Compact

Frame width is reduced by approximately 20% from current models

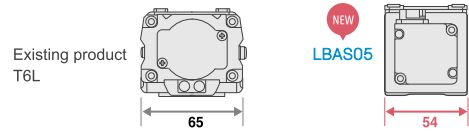

## Installation process is simple and easy

1. Mounting holes are accessible from top or bottom without disassembling actuator unit.
2. Standard surface on the side and dowel pin holes on the bottom.

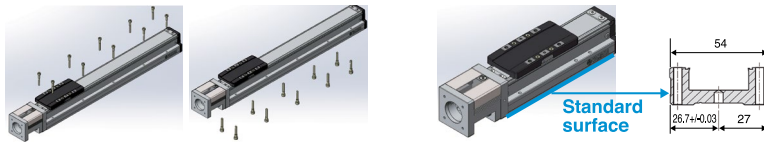

## Easy Maintenance

Moving parts can be lubricated from outside without disassembling actuator

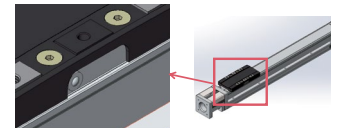

Grease zerk on the slider side surface

## Shortest Overall Length

The industry's shortest class is achieved for the total length in relation to the effective stroke.

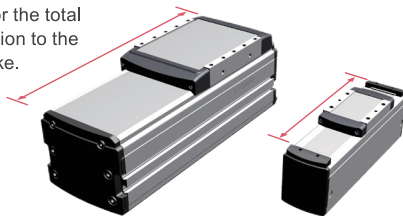

## Cleanroom Ready Design

- Protective stainless dust shield
- Ports are ready for vacuum fittings

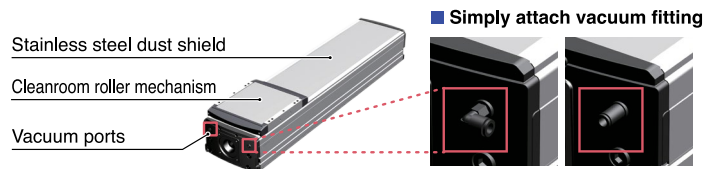

## High Precision

- Adopted ground ball screws  
Ball screw Remove Accuracy: Accuracy class C5
- Positioning Remove Accuracy repeatability:  $\pm 5 \mu\text{m}$

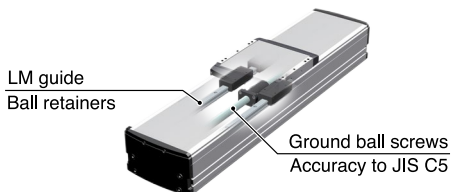

## Motor orientation is changeable with optional conversion unit

Motor unit of standard straight type can be used for side-mount setup.

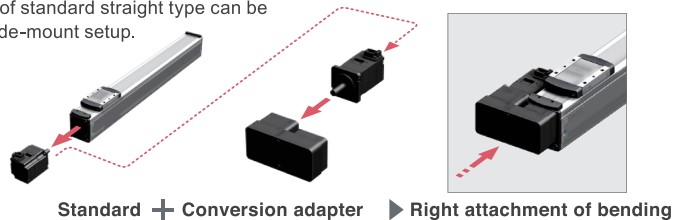

# TRANSERVO Series

## CLOSED LOOP STEPPING MOTOR SINGLE-AXIS ROBOTS

Quick selection table ▶▶ P21

Compact & economical single-axis robot, TRANSERVO series, with cost of the stepping motor and function of servo motor.

### SS Slide type

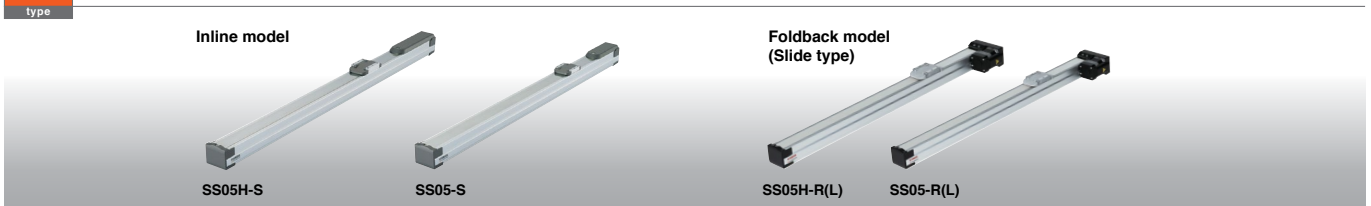

### Closed-loop control for position feedback

Stepping motors provide great features such as low cost, yet they have a drastic drop in torque at high speeds and heavy current consumption when stopped.

The TRANSERVO by YAMAHA eliminates all these problems by adopting an innovative vector control method. In effect, the TRANSERVO delivers the same functions of a servo motor while using a lower cost stepping motor.

#### Stepping Motors



- Simple design & low cost
- No vibration when it stops



- High-pitched operating noise
- Drop in torque at high-speed
- Heavy current consumption when stopped.

#### Servo Motors



- Smooth movement
- Constant torque at all speed range
- Energy saver



- Dithering
- Cost is high

TRANSERVO is combines the best features of both types

### SS type (Slide type) Features & Benefits

#### High-speed operation slashes production time

Optimizing vector control method, the TRANSERVO maintains a constant payload even in the high-speed range. This helps to drastically cut down on the tact time. By combining this feature with high-lead ball screws, the TRANSERVO has achieved a maximum speed of 1 meter per second<sup>Note</sup> which is as fast as single-axis servo motors in the same category.

Note : SS05/SS05H/SSC05/SSC05H (Lead20mm)

#### Ideal 4-row circular-groove 2-point contact guide provides longer service life

The guide maintains a satisfactory rolling movement with minimal ball differential slip, even if a large momentum load is applied or the installation surface accuracy (flatness) is bad. The rugged design ensures that breakdowns from problems like abnormal wear will seldom occur.

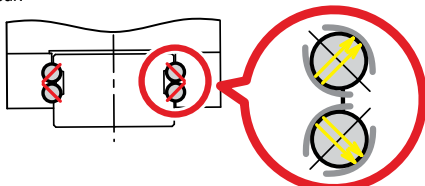

### SG Slide type

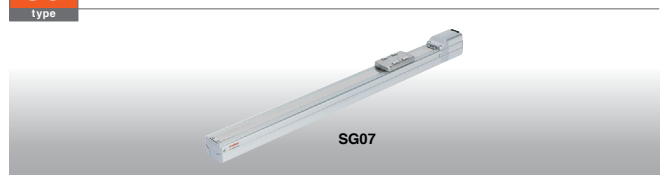

### SG type (Slider type) Features & Benefits

#### Dynamic payload capacity of 46 kg (horizontal) and 20 kg (vertical)

As rigid table slide and 56 motor are adopted, the payload is increased greatly. A maximum payload of 46 kg is achieved. Up to 20 kg can be transferred even with the vertical specifications.

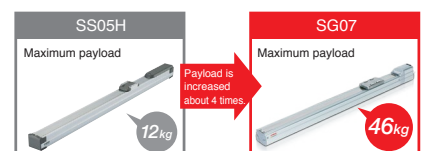

#### Maximum speed of 1200 mm/sec.

The maximum speed is made 1.2 times faster than that of the current model SS05H. The tact-up of the equipment can be achieved.



#### Improvement of maintenance ability

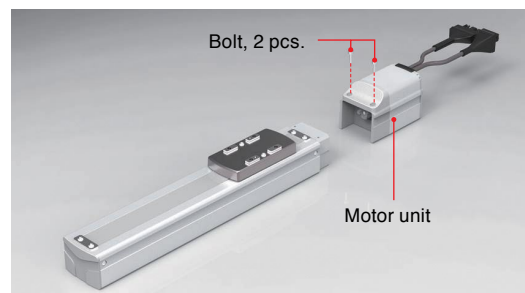

The motor unit can be detached easily by removing only two bolts. This ensures easy motor replacement.





## The position detector is a resolver

The position detector is a resolver. The resolver has a simple yet strong structure using not electronic components or elements and so has great features such as being extremely tough in harsh environments as well as a low breakdown rate. The resolver structure has none of the detection problems that occur in other detectors such as optical encoders whose electronic components breakdown or suffer from moisture or oil that sticks to the disk.

### Optical encoder

•Optical •Electronics parts are required and structure is complicated. •Electronics part trouble, disc dew condensation, or oil sticking occurs easily.

Risk that can not be detected



### Resolver

•Magnetic type •Simple structure with only the iron core and winding ensures less potential failure. •Highly resistant to impact and electric noise.

High reliability

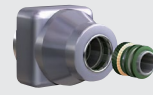

## SR Rod type

### Standard model



### Model with support guide



### Foldback model



## BD Belt type

### Inline model

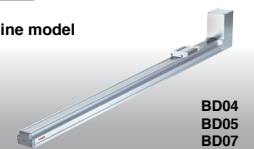

## STH Slide table type

### Inline model



### Foldback model



## RF Rotary type

### Standard model



### High rigidity model

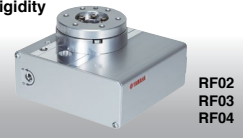

## SR type (Rod type) Features & Benefits

### Long-term maintenance free

A lubricator used in the ball screw and a contact scraper provides long-life and maintenance-free operation.

- Needs no maintenance for long periods
- Grease-saving lubrication system
- Prevents contaminant particles

### Ball screw lubricator

The lubricator contains grease in a high-density fiber net so that it supplies just the right amount of grease where needed with no waste.

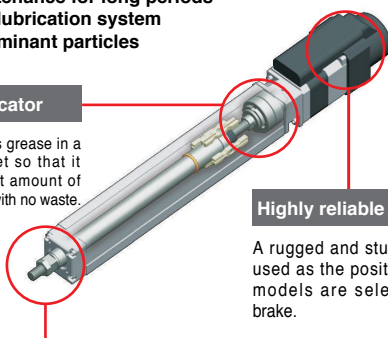

### Highly reliable resolver

A rugged and sturdy resolver is used as the position sensor. All models are selectable with a brake.

### Layered contact scraper

The dual-layer scraper prevents micro-contaminants adhering to the rod from penetrating to the inside. This is also effective in suppressing looseness or vibration in the rod.

## BD type (Belt type) Features & Benefits

### For long stroke applications

**Maximum stroke 2000mm, Maximum speed 1500mm/sec.** This type is applicable to a long stroke of up to 2000 mm. The maximum transfer speed is 1500 mm/sec., ensuring high-speed operation. The main body can be conveniently installed without removing exterior parts, such as the cover. Additionally, the shutter is provided as standard accessory. It covers the guide and belt securely to prevent grease from scattering and to block entry to external foreign objects. This type is optimal for workpiece positioning or long-distance transfer.

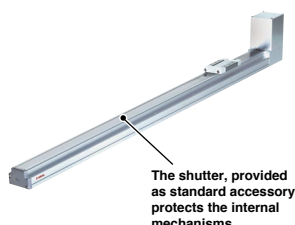

The shutter, provided as standard accessory, protects the internal mechanisms.

## STH type (Slider table type) Features & Benefits

### Circulation type linear guide for high rigidity and accuracy

**Maximum pressing force 180N, Repeatability ±0.05mm.** Integration of the guide rail and slider, this ensures less deflection. The circulation type linear guide makes it possible to provide high rigidity and accuracy. "STH06" provides an allowable overhang that exceeds "T9" of the FLIP-X series. Also, foldback models with the side mounted motor built into the body. The STH type is optimal for precise assembly.

### Dowel pin for positioning

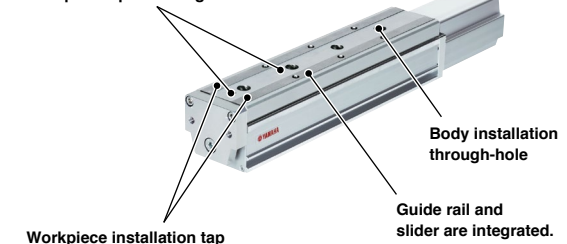

### Workpiece installation tap

## RF type (Rotary type) Features & Benefits

### First rotation axis model in TRANSERVO series

**Maximum speed 420°/sec, Repeatability ±0.05°.** The RF type is a thin and electric rotary type actuator. The two model types, standard type and high rigidity type, can be selected as the optimal applications. The RF type has very easy-to-use specifications that allow easy installation of the workpiece on the table and installation on the base frame. This type can be used for the rotation transfer after chucking or the vertical rotation operation by combining it with the gripper.

High rigidity type bearing reduces the free play in the radial and thrust directions of the table.



### High rigidity model

# FLIP-X Series

## SINGLE-AXIS ROBOTS

Quick selection table ▶▶ P20

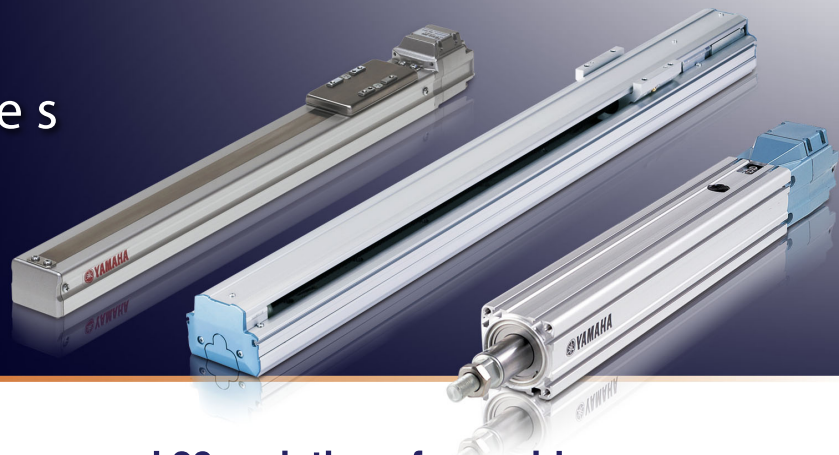

Single-axis robot series include 6 types and 29 variations for a wide range of selections.

**T Compact model**  
type T4L/T4LH, T5L/T5LH, T6L, T9/T9H

Double appeal of a compact body and low price. Ideal in applications as an actuator directly installed on a mount.

**N Nut rotation model**  
type N15/N15D, N18/N18D

The operation can be made even at a long stroke while keeping the maximum speed without being affected by the critical speed. Double carrier specifications are also available as a standard.

**F GF High rigidity model**  
type F8/F8L/F8LH, F10/F10H, F14/F14H, F17/F17L, F20/F20N, GF14XL/GF17XL

Highly rigid aluminum frame is used, allowable load moment is large, and resistance to the offset load is provided. This model is suitable for the Cartesian robot that needs the rigidity for the arm and the moving arm that moves the overall axis.

**B Timing belt drive model**  
type B10, B14/B14H

Maximum stroke length of 3050mm. Allows long distance transport between job processes.

**R Rotary axis model**  
type R5, R10, R20

Position repeatability accuracy of  $\pm 30$ seconds (0.0083"). The R type can be used as the rotation axis when combined with other robots, or utilized for a wide range of applications such as index tables. Harmonic drive delivers high-strength and high-accuracy.

### Resolver with excellent environmental resistance capability

Resolver with high reliability is adopted to detect the motor position. This enables stable position detection even in a harsh environment where powder particles or oil mists exist. Additionally, a high resolution of 20480 pulses per revolution is provided.

**Optical encoder**

- Optical
- Electronics parts are required and structure is complicated.
- Electronics part trouble, disc dew condensation, or oil sticking occurs easily.

**Risk of detection failure**

**Resolver**

- Magnetic type
- Simple structure with only the iron core and winding ensures less potential failure.
- Highly resistant to impact and electric noise.

**High reliability**

### Custom order specifications for each model are available.

We gladly accept special orders for all models such as for double sliders or wide sliders. Please consult with our sales office for more information.

### 4-row circular-groove 2-point contact guide to support large moment load.

4-row circular-groove 2-point contact guide with less differential slip is adopted. According to its structure, the differential slip of the ball is small when compared to the 2-row gothic-arch-groove 4-point contact guide. This guide maintains excellent rolling motion even when a large moment load is applied or the installation surface accuracy is poor, and has characteristics that are difficult to produce a malfunction, such as unusual wear.

**Conventional 2-row gothic arch groove 4-point contact guide**

**Large differential slip, and large friction resistance**

- Very susceptible to effects from poor installation precision, friction and elastic deformation
- Might break even within the calculated service life.

**YAMAHA's 4-row circular arc groove 2-point contact guide**

**Small differential slip and good self-centering**

- Highly resistant to alignment fluctuations and moment loads
- Resistant to breakage

### Long-service life greatly reduces the maintenance and control costs.

YAMAHA's highly rigid ball screw or guide greatly contributes to reduction of the customer's maintenance and control costs.

# PHASER Series

## LINEAR MOTOR SINGLE-AXIS ROBOTS

Quick selection table ▶▶ P21



No speed deration needed up to 4m long stroke.  
Delivers superb performance in long distance transport.

### MF Long stroke & high-power using flat motor with core

type

Double Carriages Standard on all Modules

- Maximum stroke : 4050mm
- Maximum speed : 2500mm/s
- Repeated positioning accuracy : ±5μm
- Maximum payload : 7 to 160kg

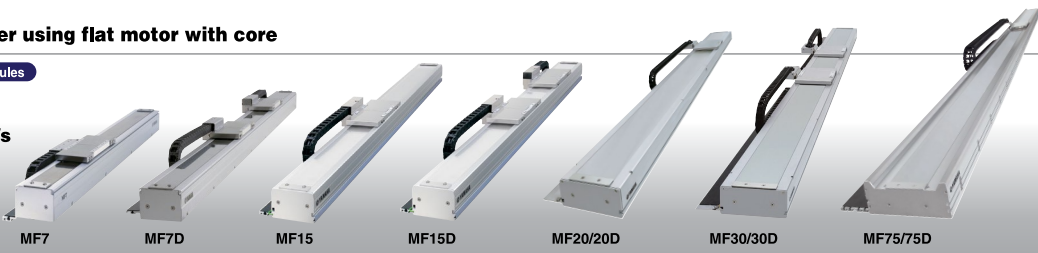

### Low cost by YAMAHA's in-house design components.

YAMAHA originally developed the magnetic scale and still manufactures it. As YAMAHA also manufactures other major components, large cost reduction is achieved. Today is an era that the linear is not a special mechanism and can be appropriately selected in comparison to the ball screw.

Particularly, when transferring a lightweight workpiece a long distance at a high speed, selecting the linear motor type will reduce the cost.

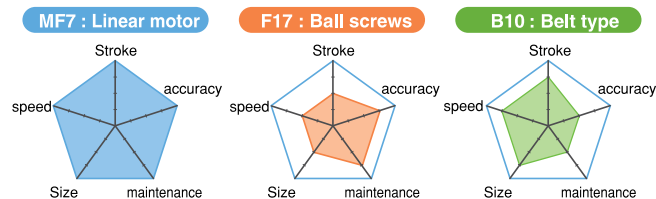

### Comparison of single-axis robot models

Model	Unit Cost <sup>Note1</sup>	Maximum speed (mm/sec)	Payload (kg)	Repeatability (μm)	Maximum stroke (mm)	Frame dimension <sup>Note2</sup> (mm)
MF7-1500		2500	10(7) <sup>Note3</sup>	±5	4000	W85×H80
F17-40-145		720 <sup>Note4</sup>	40	±10	1450	W168×H100
B10-1450		1850	10	±40	2550	W100×H81

Note1 : Comparisons when using the strokes shown above Note2 : No flexible cable guide is included. Note3 : This value becomes 7kg when the maximum speed is 2500mm/s (2100mm/s when transferring 10kg). Note4 : This value considers the critical speed when the stroke is 1450mm.

### High speed , Long Travel

The ultimate appeal of linear motor single-axis robots is that there is no critical speed limits such as with ball screws. There is no reduction in the maximum speed even when traveling long distances. Moreover, the maximum stroke is a standard setting of up to 2m on the MR type and to 4m on the MF type. The cycle time in particular for long distance conveyance has been drastically improved.

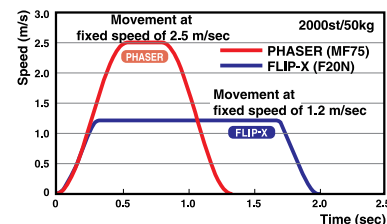

Move profile of linear single-axis PHASER and single-axis robot FLIP-X

### Standard double carrier set-up for space saving and high efficiency.

Cost and space are reduced when compared to the use of two single-axis robots.

Additionally, the axis alignment is not needed and the tools can also be made common. This shortens the setup time. (When using the RCX series controller, the anti-collision control function can be used.)

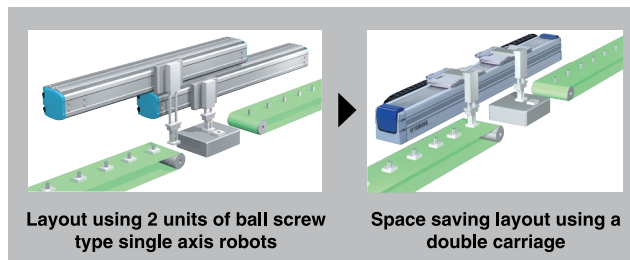

Layout using 2 units of ball screw type single axis robots

Space saving layout using a double carriage

### 160 kg maximum payload capacity of MF Series

The MF series robot adopts the flat type magnet. It can transfer a heavy object at a high speed with a high accuracy.

### Lower noise level and longer life

Comparing with ball screw type robots, there are few sliding and rotating sections so the operation is amazingly quiet. Moreover the coil and magnet do not make contact so there is no wear and the robot can be used for extended periods.



# XY-X Series

## CARTESIAN ROBOTS

Quick selection table ▶▶ P21

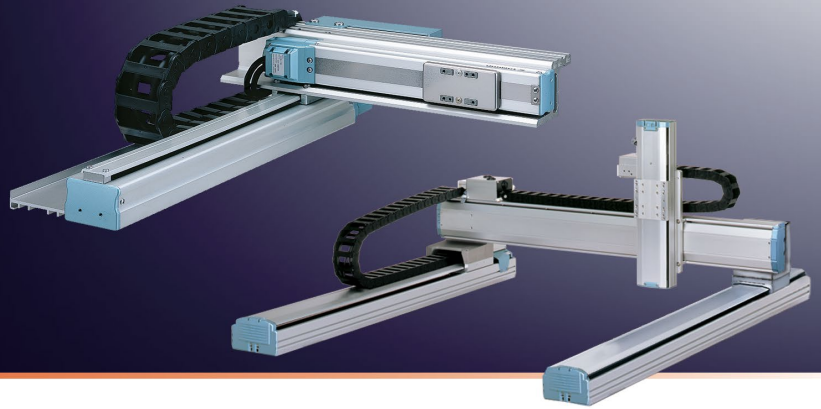

### Custom orders

Custom designed multi-axis system is available. Please consult nearby YAMAHA representatives.

Wide variety of pre-configured multi-axis systems to choose from.  
From compact economical light duty to large heavy duty systems.

#### Arm type



#### Gantry type



#### Moving arm type



#### XZ type



#### Pole type



#### Dual-synchronous drive

Equipped with the dual drive function to control 2 axis in synchronization, which is of effective use for carrying heavy items and long stroke operation with the Cartesian robot.

Note. For the dual drive function, custom order arrangement is required.

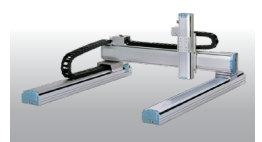

#### Various variations

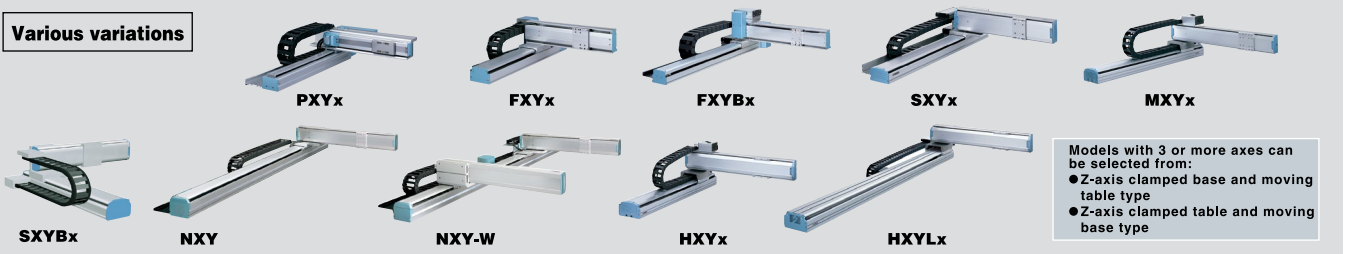

Models with 3 or more axes can be selected from:  
 ● Z-axis clamped base and moving table type  
 ● Z-axis clamped table and moving base type

### Durable and Reliable Position

#### Detection: Resolver

The position detector is a resolver. The resolver has a simple yet strong structure using non-electronic components or elements and so has great features such as being extremely tough in harsh environments as well as a low breakdown rate. The resolver structure has none of the detection problems that occur in other detectors such as optical encoders whose electronic components breakdown or suffer from moisture or oil that sticks to the disk. Moreover, **mechanical specifications for both absolute and incremental are common to all controllers** so one can switch to either absolute or incremental specifications just by setting a parameter.

Also, even if the absolute battery is completely worn down, the XY-X can operate on incremental specifications so in the unlikely event of trouble one can feel secure knowing that there will be no need to stop the production line. The backup circuit has been completely renovated and now has a backup period extending to 1 year.

#### Economy Solution

We achieved an even lower price by cutting down the number of parts while boosting basic performance. Using a resolver in the structure helped to finally eliminate the "absolute units are expensive" idea. Moreover, the mechanical components are the same regardless of whether incremental or absolute unit specifications are used.

#### Field Serviceable Structure

Even though it uses a built-in structure, components such as the motor and ball screw can be replaced individually so maintenance tasks are smooth and simple.

### 4-row 2-point groove guide rail for superb durability.

4-row circular-arc-groove 2-point contact guide with less differential slip is adopted. When compared to the 2-row gothic-arch-groove 4-point contact guide, the 4-row circular-arc-groove 2-point contact guide has characteristics that the differential slip of the ball is small due to its structure and excellent rolling motion is maintained even when a large moment load is applied or the installation surface accuracy is poor. So this guide is difficult to produce a malfunction, such as unusual wear.

#### 2-row gothic arch groove 4-point contact guide

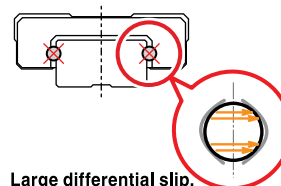

Large differential slip, and large friction resistance

- Very susceptible to effects from poor installation precision, friction and elastic deformation
- Might break even within the calculated service life.

#### 4-row circular arc groove 2-point contact guide

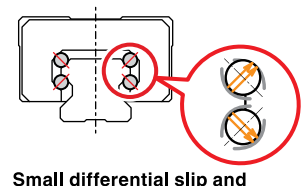

Small differential slip and good self-centering

- Highly resistant to alignment fluctuations and moment loads
- Resistant to breakage



# MULTI-FLIP / MULTI-PHASER MULTI-AXIS ROBOT



## One controller for multiple single-axis robots.

### The advantage of multi-axis controller operation

- Sequence control is simple. System upgrades are inexpensive.
- More compact and saves more space than when operating multiple single-axis controllers.
- Allows more sophisticated control.
- Multi-axis controllers RCX320/RCX340 provide mixed control of the (linear single-axis) PHASER series and FLIP-X series.

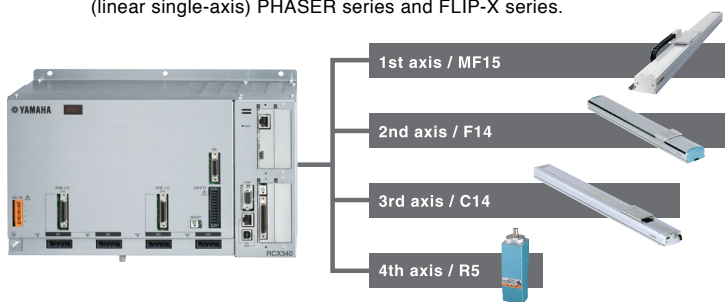

[Example]  
4 axes controller

### Robot set-up

#### 2-unit robot setting:

Using a multi-task program along with this 2-unit setting allows asynchronous independent operation. Using this along with an auxiliary axis setting allows even more freedom in assigning axes to tasks.

#### Synchronized double carrier:

This setting allows adding 2 motors to 1 axis on robot types where the motor unit runs separately such as the linear motor single-axis PHASER series or the N-type (nut rotation type) FLIP-X series.

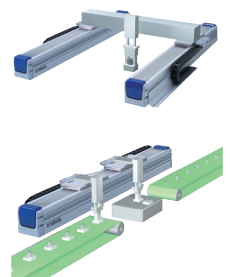

#### Main auxiliary axis setting:

Use this auxiliary axis setting when simultaneous movement with the MOVE command is impossible. An axis set for the main auxiliary axis moves only by the DRIVE command (axis separate movement command) and cannot operate from the MOVE command. Using this setting is recommended for operating on an axis that is not synchronized with the main robot.

#### Synchronized dual setting:

Make this setting when operating dual -drive (2-axis simultaneous control). Use this dual-drive setting on gantry type Cartesian robots having a long Y axis stroke when stabilizing at high acceleration/deceleration or when high-thrust is needed with high loads.

# YP-X Series

## PICK & PLACE ROBOTS

Quick selection table ▶▶ P20

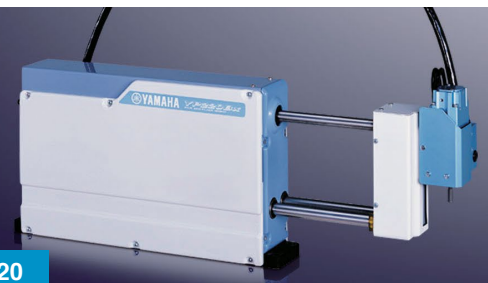

## Ideal for high-speed pick & place tasks of small parts.

## Positioning by servo control to eliminate mechanical adjustment.

### 2 axes type

YP220BX  
YP320X



### 3 axes type

YP220BXR  
YP320XR  
YP330X



### 4 axes type

YP340X



### High speed

High speed pick & place operation contributes largely to higher productivity. YP220BX under operation conditions of 50mm in vertical direction, 150mm in longitudinal direction, 50 in arch volume and 1kg load can achieve a total cycle time of .45 seconds.

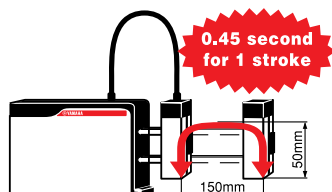

### High repeatability

Both extremely high-speed performance and high repeatability of +/-0.02mm (YP320X, YP320XR, YP330X, YP340X) are assured.

### Compact size

Compact size with an overall length of 109mm (YP220BX) and moving arm mechanism enable construction of a space saving production line with less interference with surroundings.

# YK-X Series

## SCARA ROBOTS

Quick selection table ▶▶ P22

- YK-XG Direct Drive beltless model
- YK-XE Low cost high performance model
- YK-XGS Wall mount/inverse model
- YK-XGP Dust-proof & drip-proof model



**Arm length of 120mm to 1200mm.**  
**Widest selection in industry.**  
**High-speed high-precision operation contributes to increased productivity.**

### Extra small type SCARA model

YK120XG, YK150XG  
 YK180XG, YK180X  
 YK220X

- Arm length : 120mm to 220mm
- Maximum payload : 1kg

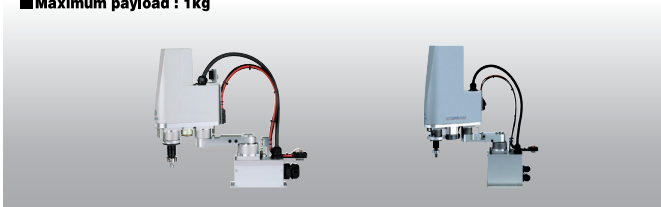

### Medium type

YK500XGL / XG  
 YK600XGL / XG/XGH

- Arm length : 500mm to 600mm
- Maximum payload : 5kg to 20kg



### Small type

YK250XG  
 YK350XG  
 YK400XG

YK400XE

- Arm length : 250mm to 400mm
- Maximum payload : 5kg

- Arm length : 400mm
- Maximum payload : 4kg

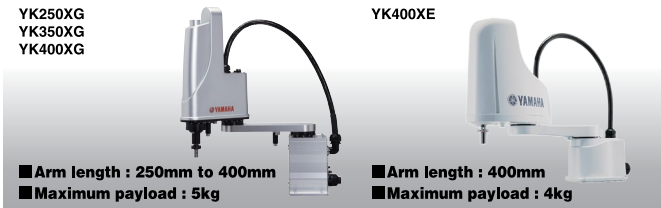

### Large type

YK700XGL  
 YK700XG  
 YK800XG  
 YK900XG  
 YK1000XG  
 YK1200X

- Arm length : 700mm to 1200mm
- Maximum payload : 10kg to 50kg



Note : YK700XGL is a custom order model.  
 Please consult YAMAHA representative for details.

### Wall-mount / inverse model

YK300XGS, YK400XGS  
 YK500XGS, YK600XGS  
 YK700XGS, YK800XGS  
 YK900XGS,  
 YK1000XGS

- Arm length : 300mm to 1000mm
- Maximum payload : 20kg



#### Wall-mount type

Type where the robot body is installed in the wall.

#### Inverse type

Type where wall-mount type is mounted upside down.

### Dust-proof & drip-proof model

YK250XGP, YK350XGP  
 YK400XGP, YK500XGP  
 YK500XGLP, YK600XGP  
 YK600XGLP, YK700XGP  
 YK800XGP, YK900XGP  
 YK1000XGP,

- Arm length : 250mm to 1000mm
- Maximum payload : 20kg



Designed for applications in environment with water splash and dust (protection class equivalent to IP65).  
 • Please consult us for anti-droplet moisture protection for anything other than water.  
 Note : YK700XGP/YK800XGP/YK1000XGP is a custom order model.  
 Please consult YAMAHA representative for details.

### 30 Years of history

The first robot YAMAHA released was SCARA robot. Since that first SCARA robot called "CAME" was produced in 1979, some 30 years of SCARA robot innovations have been developed. These SCARA robots have undergone countless modifications in an ever-changing marketplace and amassed a hefty record of successful products making them an essential part of the YAMAHA robot lineup.



1979  
 <YK7000>

### Internal structure designed for optimal operation

Note : Example shown is YK500XG.

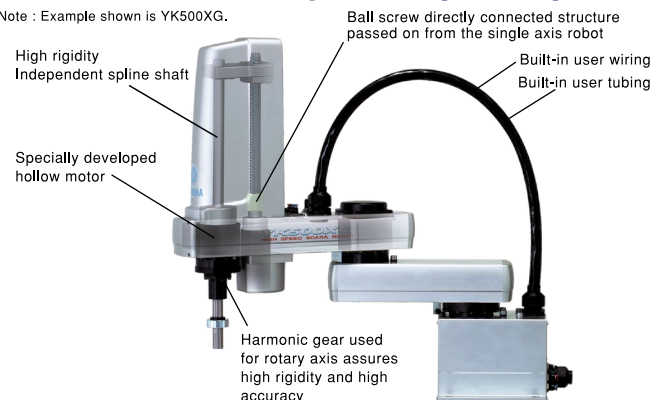

## Completely beltless structure

A totally beltless structure was achieved by using a ZR axis direct coupling structure. This direct drive structure drastically reduces wasted motion. It also maintains high accuracy over a long period of time. It ensures maintenance-free usage for extended periods with no worries about belt breakage, stretching or deterioration with age (feature applies to all XG series models and the YK180X/YK220X).

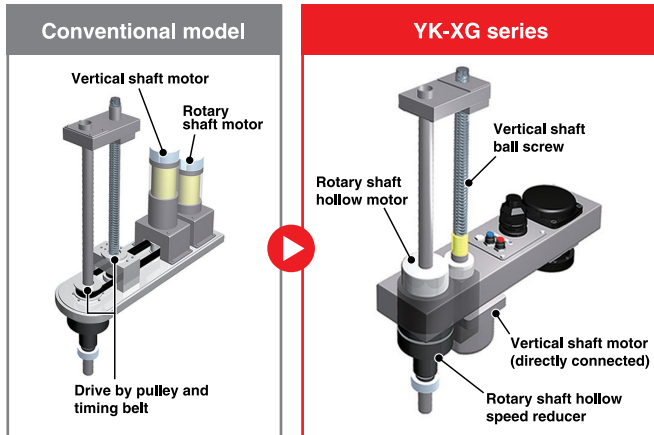

## Environmentally rugged resolver provides closed loop control

The position detector is a resolver. The resolver has a simple yet strong structure using not electronic components or elements so these features make the structure extremely tough in harsh environments with a low breakdown rate. The resolver structure has none of the detection problems that occur in other detectors such as optical encoders whose electronic components breakdown or suffer from moisture or oil that sticks to the disk. Moreover, **mechanical specifications for both absolute and incremental are common to all controllers** so one can switch to either absolute or incremental just by setting a parameter.

Also if the absolute battery is completely worn down, the SCARA can operate on incremental. In the unlikely event of trouble one can feel secure knowing that there will be no need to stop the production line. The backup circuit has been completely renovated and now has a backup period extending to 1 year.

Note : The resolver has a simple structure not using electronic components at all. It is highly resistant to low and high temperatures, impacts, electrical noise, dust particles, oil, etc. and is used in automobiles, trains, and airplanes.

### Optical encoder



- Optical
- Electronics parts are required and structure is complicated.
- Electronics part share trouble, with disc condensation, oil sticking.

▼

**Risk of detection failure**

### Resolver



- Magnetic type
- Simple structure with only the iron core and winding ensures less potential failure.
- Highly resistant to impact and electric noise.

▼

**High reliability**

## Superior rotary axis inertia moment capacity

SCARA robot performance is not limited to just standard cycle time. Actual work situations include a diverse range of heavy work pieces as well as work with large offsets. Using a low R axis inertia moment in those cases will help drastically cut the cycle time. All YAMAHA SCARA robots have a speed reducer directly coupled to the tip of the rotating axis. The R axis produces an extremely high allowable inertia moment which delivers high speed operation compared to structures where positioning is usually done by a belt after decelerating.

**YK120XG**  
(R axis allowable moment inertia : 0.1kgfcm<sup>2</sup>)

**If the tip load weight is 1kg, it is possible to operate at about 100mm offset.**

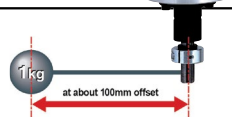

### ● R axis allowable inertia moment : Comparing YK120XG with competitor's models

Figures when using 1kg load		Operation	
Offset (mm)	Inertia (kgfcm <sup>2</sup> )	Operation	
		YK120XG	A Corp.
0	0.0039	○	○
45	0.025	○	×
97	0.1	○	×

◆ R axis allowable inertia moment : YK120XG ..... 0.1kgfcm<sup>2</sup>  
A Corp. .... 0.0039kgfcm<sup>2</sup>

## High speed

The standard cycle time is fast of course but the YAMAHA design also stresses cycle time in the actual usage region. A drastic improvement in maximum speed was made by changing the gear ratio and maximum motor rpm. This also resulted in a better cycle time during long distance movement.

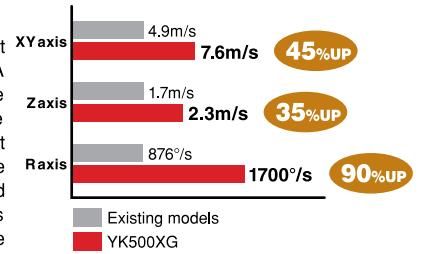

## Hollow shaft and tool flange options

Useful options include a hollow shaft for easy wiring to the tip tool and a tool flange for tool clamping.

Note : YK250XG/YK350XG/YK400XG/YK500XGL/YK600XGL



Hollow shaft option for easy routing of air tubes and harness wires

Tool flange option for easy mounting of a tool to the tip

## Improved maintenance features

The covers on the YAMAHA SCARA robot YK-XG series can be removed from the front or upwards. The cover is separate from the cable so maintenance tasks are easy.

On ordinary robots replacing the grease on the harmonic gear takes a great deal of time and trouble because the gear must be disassembled and position deviations might occur. On YAMAHA SCARA robots however the harmonic gear is the grease-sealed type so no grease replacement is needed (YK-500XG to YK1000XG).

## Superior performance at low cost

For improved efficiency and reliability in production at affordable price.

YK-XE

## Features of wall-mount / inverse type

Completely beltless structure ensures high rigidity.

YK-XGS

As the conventional ceiling-mount type was changed to the wall-mount type, the flexibility of the system design is improved. This enables downsizing of the production equipment. Additionally, as the inverse type allowing upward operation is added to the lineup, the flexibility of the work direction becomes wide. Additionally, completely beltless structure achieves a maximum payload of 20kg and a R-axis allowable inertia moment of 1kgm<sup>2</sup>\* that is the maximum level in this class. A large hand can also be installed. This robot is suitable for heavy load work.

Note : YK700XGS to YK1000XGS

## Dust-proof and Drip-proof type

Bellows improved dust/drip proofing capability

YK-XGP

The conventional robot was renewed to a dust-proof and drip-proof type completely beltless structure that can be used in a work environment where water droplets or dust particles scatter.

Belt deterioration is eliminated and the robot is highly resistant to harsh environments. Additionally, using up/down bellows structure makes it possible to improve the dust-proof and drip-proof performance.

Note : YK250XGP to YK600XGLP

• Equivalent to protection grade IP65(IEC60529)  
• Dust-proof and drip-proof connector for user wiring is available as a standard.

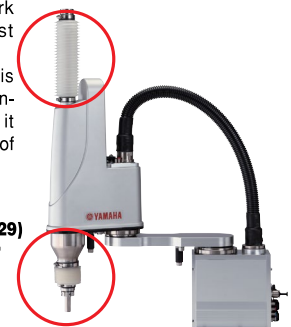



# YK-TW Series

## ORBIT TYPE SCARA ROBOT YK350TW YK500TW



Quick selection table ▶▶ P22

### Superior Positioning Accuracy and High Speed Enables a smaller equipment footprint by eliminating the dead space at the center of the movement range.

#### YK-TW can move anywhere through the full φ1000 mm\*2 work envelope.

Featuring a ceiling-mount configuration with a wide arm rotation angle, the YK-TW can access any point within the full φ1000 mm downward range. This eliminates all motion-related restrictions with regard to pallet and conveyor placement operations, while dramatically reducing the equipment footprint.

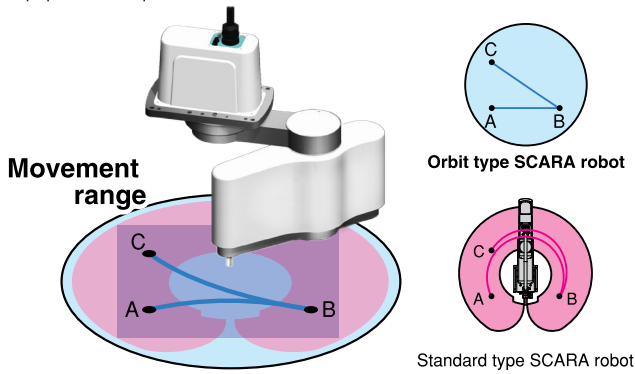

#### YK-TW offers a repeated positioning accuracy of ±0.01 mm\*1 (XY axes).

Higher repeated positioning accuracy than that offered by a parallel-link robot. This was accomplished by optimizing the robot's weight balance through an extensive re-design of its internal construction. The lightweight yet highly rigid arm has also been fitted with optimally tuned motors to enable high accuracy positioning.

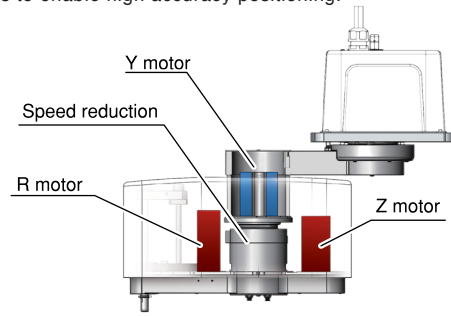

<b>Hollow construction</b>	<b>Optimized rotation center of gravity moment</b>
Y-motor and reduction gear feature a hollow construction which allows them to be housed inside the harness arm.	Weight balance was optimized by placing the R-motor and Z-motor at the left and right sides respectively.
360° Rotation.	Reduced inertia enables high-speed motion.

#### Ideal for narrow space applications

Minimum installation width **492mm**

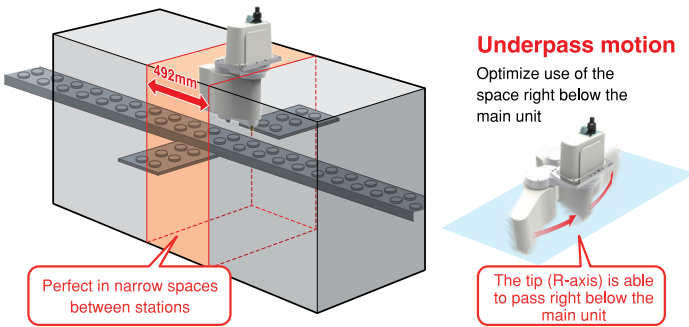

#### YK-TW offers both a lower profile and a smaller footprint.

YK-TW height is only 392 mm. This compact size enables more freedom in the equipment layout design.

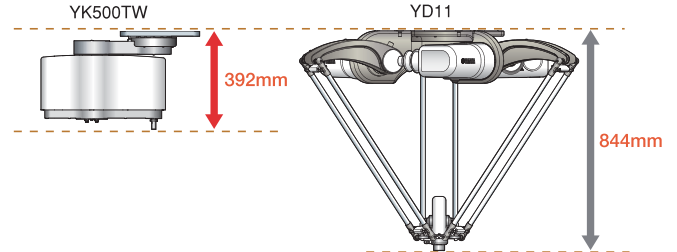

#### Standard cycle time of 0.29 secs.\*2

Y-axis (arm 2) passes beneath the X-axis (arm 1) and it has a horizontal articulated structure, allowing it to move along the optimal path between points. Moreover, the optimized weight balance of the internal components reduces the cycle time by 36% as compared to previous models.



#### YK-TW has a total height of only 392 mm, and weighs only 27 kg\*2. Lower inertia = Lighter frame

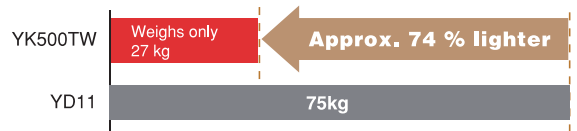

The standard cycle time for moving a 1-kg load horizontally 300 mm and up/down 25 mm is shortened by approximately 36% compared to existing YAMAHA models.

An optional dedicated installation frame is available for the YK-TW. For details, contact a YAMAHA sales representative.

\*1. Applies to the YK350TW \*2. Applies to the YK500TW



# CLEANROOM Type

## CLEAN ROBOTS

Quick selection table ▶▶ P22-23



**Class 10 rating sealed structure reduces particle generation, and air-intake efficiency improvement to establish both high cleanliness and high performance.**

### YK-XGC/XC

type

#### Cleanroom SCARA robots

- Arm length : 180mm to 1000mm
- Intake air : 30 to 60N /min
- Degree of cleanliness : CLASS ISO3 (ISO14644-1)  
CLASS10 (FED-STD-209D)
- Maximum payload : 20kg



YK250XGC



YK400XGC

The Z-axis spline is covered with bellows made of materials with lower dust emission and other sliding parts are sealed completely. The harness is also completely built-in and the suction inside the robot is performed from the rear of the base to prevent dust emission.

**Bellows on vertical axis improves reliability of the clean performance.**

**Completely beltless structure improves rigidity.**

### FLIP-XC

type

#### Cleanroom Single-axis robots

- Stroke : 50 to 2050mm
- Intake air : 15 to 90N /min
- Cleanliness rating : CLASS 10 <sup>Note</sup>
- Maximum payload : 120kg (Horizontal installation)

Note : C4L/C4LH, C5L/C5LH, and C6L conform to CLASS ISO3 (ISO14644-1).

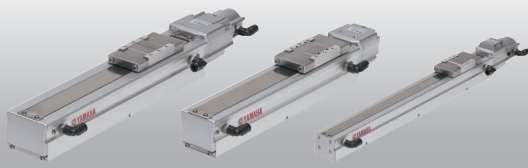

C6L

C5L

C4L

Cleanroom specifications of "FLIP-X series". An appropriate model suitable for the application can be selected from 14 models ranging from lightweight and compact model to large model with a maximum payload of 120 kg. A suction air joint is available as a standard, low dust emission grease is used, and stainless steel sheet with excellent durability is mounted on the slide table surface to achieve high cleanliness.

### SSC

type

#### Cleanroom Single-axis robots (TRANSEVO)

- Stroke : 50 to 800mm
- Intake air : 15 to 80N /min
- Cleanliness rating : CLASS 10
- Maximum payload : 12kg (Horizontal installation)

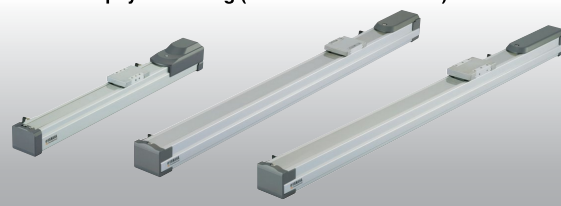

SSC04

SSC05

SSC05H

Cleanroom specifications of "TRANSEVO series". Use of a newly developed vector control system with adoption of stepping motor makes it possible to achieve the functions and performances similar to the servomotor at a low cost.

A suction air joint is available as a standard, low dust emission grease is used, and stainless steel sheet with excellent durability is mounted on the slide table surface to achieve high cleanliness.

## Improved maintenance features

### XY-XC

type

#### Cleanroom cartesian robots

- Intake air : 60 to 90N /min
- Cleanliness rating : CLASS 10
- Maximum payload : 20kg
- Maximum speed : 1000mm/sec

Note : User cable D-Sub 25 pin connector 24 conductors, 0.3 sq

Note : User tube three 6 air tubes.

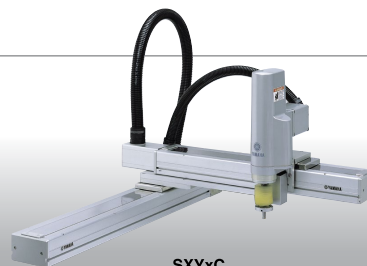

SXYxC

Cleanroom applicable type of "Cartesian robot". Use of stainless steel sheets with excellent durability makes it possible to design the opening at its minimum level. The robot is applicable to CLASS10 with less suction amount. Furthermore, as a super-high speed unit of the SCARA robot is used for the ZR-axis of SXYxC, the cycle time is greatly shortened.

# CONTROLLERS

## CONTROLLERS



Wide range of control systems to choose from.  
From single axis positioner to multi-axis comprehensive absolute controller covering DC Stepping Motor, AC Servo Motor, and Linear Motor.

	TRANSERVO Stepping motor	FLIP-X [T4L/T5L] Small servo (24V · 30W)	General-purpose servo (30 to 600W)	PHASER Linear motor
1 axis	<ul style="list-style-type: none"> <li>I/O point trace</li> <li>Remote command</li> </ul>			
	<ul style="list-style-type: none"> <li>Pulse train</li> </ul>			
	<ul style="list-style-type: none"> <li>Program (YAMAHA SRC language)</li> <li>I/O point trace</li> <li>Remote command</li> <li>Online instructions</li> </ul>			
2 axes				
3, 4 axes				
5 to 6 axes				
up to 16 axes	<p><b>YC-Link/E</b></p> <p>Up to four RCX340 controllers (up to 16 controllable axes) can be connected.</p> <p>All programs and settings are managed using the master.</p> <p>Connectable using LAN cable, YC-Link/E</p> <p>Controllers without program settings</p>			

### P Robot positioner



Simple operation only by specifying point number data

The TS series are robot positioners that operate just by specifying a point No. and entering a START signal. These can do positioning or push operations without having to write a program. Speed changes can be made during movement by carrying out linked operation.

### D Robot driver

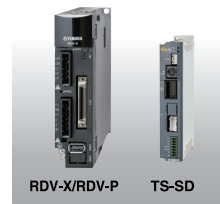

Pulse train input driver for single-axis robot

As the operation with the robot language is omitted and the driver is dedicated to the pulse train input, the driver can be easily built into the automatic machine unit as a compact control unit.

### C Robot controllers



#### Diverse command methods

Select an optimal method from the different command methods including program operation, point trace, remote command, and on-line command. Program uses the YAMAHA SRC language resembling BASIC. Use it to execute a variety of operations ranging from simple tasks to I/O output and conditional branching, etc.

#### Powerful support software

The low-cost and high-performance TS-Manager was newly developed for the TS series. This single software performs all operations such as point data settings, editing, backup and teaching tasks. It also comes loaded with real-time trace functions, current values, and voltage values.

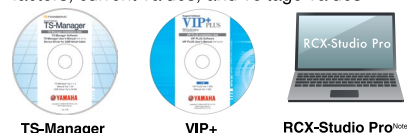

Note : This software is only downloaded from the website.



# iVY2 System

## ROBOT VISION FOR THE RCX340



**A robot-integrated vision system means simplicity, high functionality, and reliability. Ease of original iVY, with greatly improved performance.**

### Supporting five-megapixel cameras

(Choose from 300,000 pixel, 1.3 megapixel, 2 megapixel and 5 megapixel)

Detailed edge detection is possible even if workpieces are touching each other or have a complex shape.

A single search allows detection even for a large workpiece, improving takt.

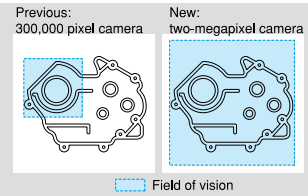
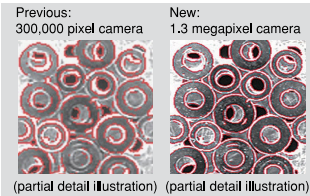

### System configuration illustration iVY2

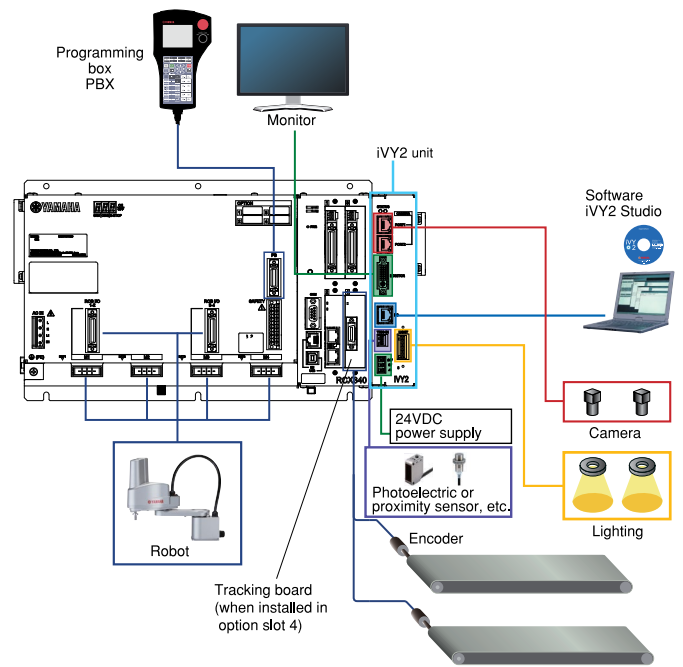

\* The illustration above shows an example system with the tracking board and an iVY2 unit (when the lighting control board option is selected).  
\* Connections to the STD.DIO, ACIN, and SAFETY connectors are not shown in the above illustration.

### Approximately double the search speed (compared to previous model)

The search speed is approximately double that of the previous model. Even a large number of workpieces can be detected at high speed. This can be used for a wide variety of applications, including molded plastic parts or food items.

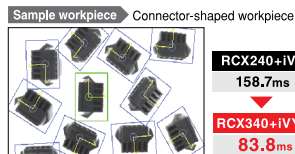

### 254 types can be registered

Setup changes require only that part numbers be changed.

254 types (0 to 253) can be registered



### With monitor output

Monitor the search status while making calibration settings or during automatic operation.



### Conveyor tracking capability up to 100 CPM.

The vision camera detects the position and orientation of parts on moving conveyor for pick & place application.

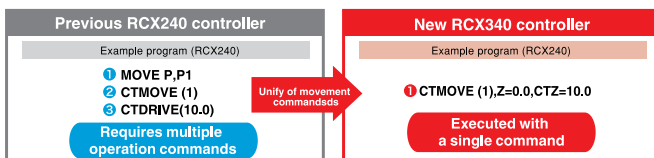

Move-up command, track workpiece command, and move-down command, in one.

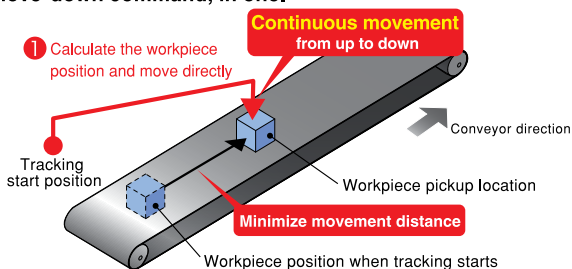

Operating conditions: YK500XG / Payload mass 1 kg (total of tool and workpiece) / Horizontal movement 250 mm / Vertical movement 1 mm / Conveyor speed 100 mm/sec

### Control multiple robots for additional increase in productivity.

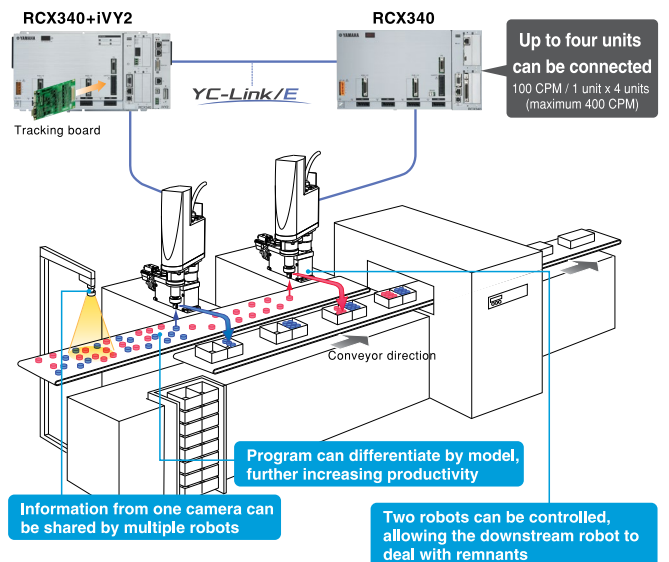



# YRG Series

## ELECTRIC GRIPPER

Quick selection table ▶▶ P21



### Easy operation by YAMAHA's robot language.

<b>Gripping power control</b> Adjustable in 1% increment from 30 to 100%.	<b>Measuring</b> Measures a workpiece by position detection.	<b>Speed control</b> Adjustable in 1% increment from 20 to 100% for speed and 1 to 100% for acceleration.	<b>Multi-point Control</b> Up to 10,000 points	<b>Workpiece check function</b> Utilizes the HOLD output signal to check if the gripper fails to grip a workpiece or drops it, without using a sensor.
--	---	--	---	---

#### S type Single cam type

Lightweight, compact, high-speed

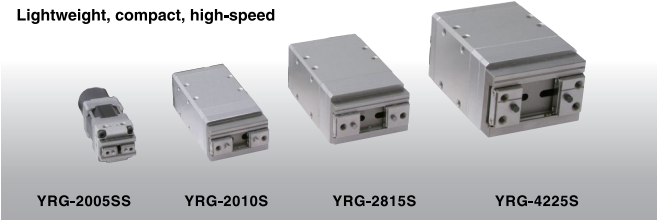

#### W type Double cam type

High gripping force



#### Screw type

**Straight style**  
High precision, long stroke



#### Three fingers type

Compact, high rigidity, long stroke

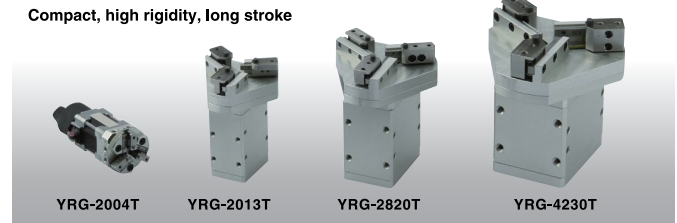



### Electric gripper for high-precision gripping force, positioning, and speed control

YRG delivers gripping power control, speed and acceleration control, multi-point positioning, and measuring of workpieces, which have been difficult for air-driven devices. The YRG proves a flexible fit for a wide range of applications.

#### Gripping force control

The gripping force can be set in 1% increments. A fragile or deformable workpiece, such as glass or spring can also be gripped. The gripping force is constant even when the finger position is changed.

<b>Pneumatic control</b> Fine adjustment of the regulator is difficult.	<b>Electric control</b> Gripping force can be set in a range of 30% to 100% in 1% increments.
	

#### Multi-point Control

The finger position can be set to a desired position corresponding to the workpiece size. This contributes to efficiency improvement of the line with workpiece size and material mixed or the line needing frequent setup.

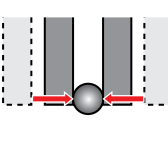
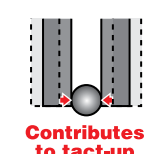
<b>Pneumatic control</b> Stroke loss is produced.	<b>Electric control</b> Stroke loss is not produced due to optimal positioning accuracy.
	
	<b>Contributes to fact-up.</b>

#### Workpiece presence check function

The electric gripper outputs the HOLD signal. Missing workpiece gripping and workpiece drop during transfer can be checked. No external sensor is needed.

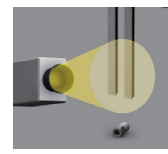
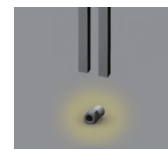
<b>Pneumatic control</b> Workpiece miss-gripping or drop is judged by the sensor or image processing.	<b>Electric control</b> Workpiece drop can be judged. No external sensor is needed.
	

#### Controllable with a single controller

The gripper can be controlled with a single controller. Since there's no need for interchange with a PLC or other host device, setup and startup is dramatically simpler.

#### Combination with a vision system supports a wide range of applications

As the YRG series is combined with controller integrated robot vision "iVY2 System", the operations from the positioning using the camera to workpiece handling can be controlled in the batch mode using the RCX340 controller. Sophisticated systems can be easily configured.

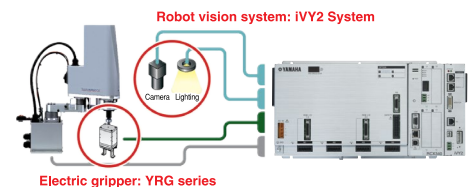

\* Can also be used with the RCX240 controller



# YA Series

## VERTICALLY ARTICULATED ROBOTS

Quick selection table ▶▶ P21

6-axis 7-axis



**Increase productivity** Ideal for constructing compact cells, moving and assembling small parts, or inspection processes.

### 6-axis



#### High-speed operation reduces cycle time

Thanks to high-speed, low-inertia AC servo motors, an arm designed for light weight, and the latest control technology, these robots achieve an operating speed that is best in their class. From supply, assembly, inspection, and packing to palletization, all applications can enjoy shorter cycle time and improved productivity.

#### Workpieces with a high wrist load are also supported

With a wrist section that has the highest allowable moment of inertia in its class, these robots can support jobs involving a high wrist load, or simultaneous handling of multiple workpieces.

#### Dramatically reduce line setup time with a simulator

We provide software that lets you use 3D CAD data to construct a production facility in virtual space in a personal computer, and easily perform engineering tasks such as creating programs and checking for robot interference. Teaching can be performed even before the actual production line is completed, dramatically reducing line startup time.

\* Optional support

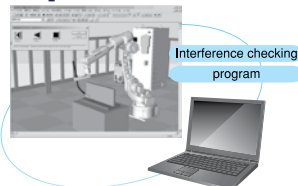

### 7-axis

#### Reduced space allows sophisticated system layouts

Since these robots can be installed close to workpieces or other equipment, you can reduce the space required for your production facility. By locating multiple robots close to each other, processing can be integrated and shortened.

### 7-axis

#### "Elbow movement" unique to 7-axis models allows optimal posture to be maintained

The 7-axis U-type robots allow "elbow movement," changing only the elbow angle without affecting the position or posture of the tool. This permits operation to avoid nearby obstructions.

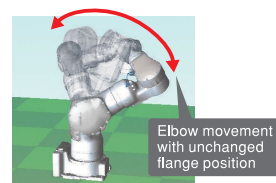

### 7-axis

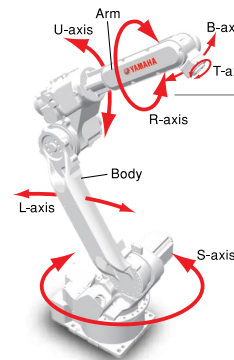
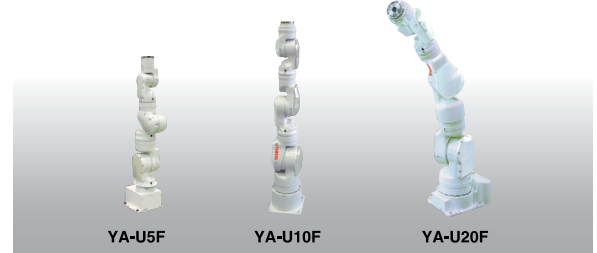

#### 6-axis robots

- S-axis: Rotate the body horizontally
- L-axis: Move the body forward/backward
- U-axis: Move the arm up/down
- R-axis: Rotate the arm
- B-axis: Move the tip of the arm up/down
- T-axis: Rotate the tip of the arm

#### Free arm movement further boosts productivity.

#### 7-axis robots

- S-axis: Rotate the body horizontally
- L-axis: Move the body forward/backward
- E-axis: Twist the arm
- U-axis: Move the arm up/down
- R-axis: Rotate the arm
- B-axis: Move the tip of the arm up/down
- T-axis: Rotate the tip of the arm

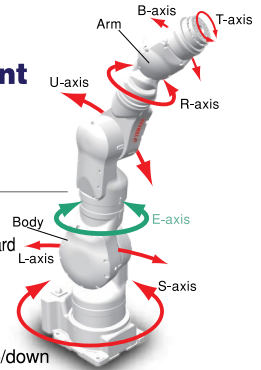

#### Controller Specifications YAC100



YAC100 Controller Specifications	
Configuration	Standard: IP20 (open structure), Option: IP54 (dustproof housing)
Dimensions	470 (W)×420 (D)×200 (H) mm (Protrusions are not included.)
Mass	20 kg
Cooling System	Direct cooling
Ambient Temperature	During operation: 0°C to +40°C During storage: -10°C to +60°C
Relative Humidity	90% max. (non-condensing)
Power Supply *	Single-phase 200/230 VAC (+10% to -15%), 50/60 Hz Three-phase 200/220 VAC (+10% to -15%), 50/60 Hz
Grounding	Grounding resistance: 100 Ω or less
Digital I/Os	Specialized signals: 10 inputs and 1 output General signals: 28 inputs and 28 outputs Max. I/O (optional): 1,024 inputs and 1,024 outputs
Positioning System	By serial encoder
Programming Capacity	JOB: 10,000 steps, 1,000 instructions C/O ladder: 1,500 steps
Expansion Slots	MP2000 bus × 5 slots
LAN (Connection to Host)	1 (10BASE-T/100BASE-TX)
Interface	RS-232C: 1ch
Control Method	Software servo control
Drive Units	Six axes for robots. Two more axes can be added as external axes. (Can be installed in the controller.)
Painting Color	Munsell notation 5Y7/1 (reference value)

\* YA-R6F: Three-phase only.

# Robonity MOTOR-LESS SINGLE AXIS ACTUATOR

## Basic model LBAS

Model	LBAS04		LBAS05				LBAS08			
Adaptable motor	50 W		100 W				200 W			
Repeatability <sup>Note 1</sup>	+/-0.01 mm		+/-0.01 mm				+/-0.01 mm			
Deceleration mechanism	Shifting position ball screw φ 10 (C7 class)		Shifting position ball screw φ 12 (C7 class)				Shifting position ball screw φ 16 (C7 class)			
Stroke	50 mm to 800 mm (50 mm pitch)		50 mm to 800 mm (50 mm pitch)				50 mm to 1100 mm (50 mm pitch)			
Maximum speed <sup>Note 2</sup> (or equivalent)	800 mm/sec	400 mm/sec	1333 mm/sec	666 mm/sec	333 mm/sec	133 mm/sec	1200 mm/sec	600 mm/sec	300 mm/sec	
Ball screw lead	12 mm	6 mm	20 mm	10 mm	5 mm	2 mm	20 mm	10 mm	5 mm	
Maximum payload <sup>Note 3</sup> (or equivalent)	Horizontal	12 kg	20 kg	12 kg	24 kg	40 kg	45 kg	40 kg	80 kg	100 kg
	Vertical	2 kg	5 kg	3 kg	6 kg	12 kg	15 kg	8 kg	20 kg	30 kg
Rated thrust <sup>Note 3</sup> (or equivalent)	71 N	141 N	84 N	169 N	339 N	854 N	174 N	341 N	683 N	
Maximum dimensions of cross section of main unit	W 44 mm × H 52 mm		W 54 mm × H 60 mm				W 82 mm × H 78 mm			
Overall length	ST + 214 mm		ST + 220.5 mm				ST + 278 mm			
Using ambient temperature and humidity	0 to 40 °C, 35 to 80 %RH (non-condensing)									

Note 1. Positioning repeatability in one direction.

Note 2. When a moving distance is short and depending on an operation condition, it may not reach the maximum speed.

Note 3. The rated thrust and maximum transferable weight are values assuming the attached motor outputs the rated torque.

## Advanced model LGXS

Model	LGXS05			LGXS05L			LGXS07				
Adaptable motor	50 W			100 W			100 W				
Repeatability <sup>Note 1</sup>	+/-0.005 mm			+/-0.005 mm			+/-0.005 mm				
Deceleration mechanism	Ground ball screw φ 12 (C5 class)			Ground ball screw φ 12 (C5 class)			Ground ball screw φ 15 (C5 class)				
Stroke	50 mm to 800 mm (50 mm pitch)			50 mm to 800 mm (50 mm pitch)			50 mm to 1100 mm (50 mm pitch)				
Maximum speed <sup>Note 2</sup> (or equivalent)	1333 mm/sec	666 mm/sec	333 mm/sec	1333 mm/sec	666 mm/sec	333 mm/sec	1800 mm/sec	1200 mm/sec	600 mm/sec	300 mm/sec	
Ball screw lead	20 mm	10 mm	5 mm	20 mm	10 mm	5 mm	30 mm	20 mm	10 mm	5 mm	
Maximum payload <sup>Note 3</sup> (or equivalent)	Horizontal	5 kg	8 kg	13 kg	12 kg	24 kg	32 kg	10 kg	25 kg	45 kg	85 kg
	Vertical	2 kg	4 kg	8 kg	3 kg	6 kg	12 kg	2 kg	4 kg	8 kg	16 kg
Rated thrust <sup>Note 3</sup> (or equivalent)	41 N	69 N	138 N	84 N	169 N	339 N	56 N	84 N	169 N	339 N	
Maximum dimensions of cross section of main unit	W 48 mm × H 65 mm			W 48 mm × H 65 mm			W 70 mm × H 76.5 mm				
Overall length	ST + 131.5 mm			ST + 161.5 mm			ST + 202 mm				
Degree of cleanliness <sup>Note 4</sup>	ISO CLASS 3 (ISO14644-1) or equivalent										
Intake air <sup>Note 5</sup>	30 Nℓ/min to 100 Nℓ/min			30 Nℓ/min to 100 Nℓ/min			30 Nℓ/min to 115 Nℓ/min				
Using ambient temperature and humidity	0 to 40 °C, 35 to 80 %RH (non-condensing)										

Model	LGXS10				LGXS12				LGXS16			LGXS20			
Adaptable motor	200 W				400 W				750 W			750 W			
Repeatability <sup>Note 1</sup>	+/-0.005 mm				+/-0.005 mm				+/-0.005 mm			+/-0.005 mm			
Deceleration mechanism	Ground ball screw φ 15 (C5 class)				Ground ball screw φ 15 (C5 class)				Ground ball screw φ 20 (C5 class)			Ground ball screw φ 20 (C5 class)			
Stroke	100 mm to 1250 mm (50 mm pitch)				100 mm to 1250 mm (50 mm pitch)				100 mm to 1450 mm (50 mm pitch)			100 mm to 1450 mm (50 mm pitch)			
Maximum speed <sup>Note 2</sup> (or equivalent)	1800 mm/sec	1200 mm/sec	600 mm/sec	300 mm/sec	1800 mm/sec	1200 mm/sec	600 mm/sec	300 mm/sec	2400 mm/sec	1200 mm/sec	600 mm/sec	2400 mm/sec	1200 mm/sec	600 mm/sec	
Ball screw lead	30 mm	20 mm	10 mm	5 mm	30 mm	20 mm	10 mm	5 mm	40 mm	20 mm	10 mm	40 mm	20 mm	10 mm	
Maximum payload <sup>Note 3</sup> (or equivalent)	Horizontal	25 kg	40 kg	80 kg	100 kg	35 kg	50 kg	95 kg	115 kg	45 kg	95 kg	130 kg	65 kg	130 kg	160 kg
	Vertical	4 kg	8 kg	20 kg	30 kg	8 kg	15 kg	25 kg	45 kg	12 kg	28 kg	55 kg	15 kg	35 kg	65 kg
Rated thrust <sup>Note 3</sup> (or equivalent)	113 N	170 N	341 N	683 N	225 N	339 N	678 N	1360 N	320 N	640 N	1280 N	320 N	640 N	1280 N	
Maximum dimensions of cross section of main unit	W 100 mm × H 99.5 mm				W 125 mm × H 101 mm				W 160 mm × H 130 mm			W 200 mm × H 140 mm			
Overall length	ST + 175.5 mm				ST + 211.5 mm				ST + 242.5 mm			ST + 288.5 mm			
Degree of cleanliness <sup>Note 4</sup>	ISO CLASS 3 (ISO14644-1) or equivalent														
Intake air <sup>Note 5</sup>	30 Nℓ/min to 90 Nℓ/min														
Using ambient temperature and humidity	0 to 40 °C, 35 to 80 %RH (non-condensing)														

Note 1. Positioning repeatability in one direction.

Note 2. When a moving distance is short and depending on an operation condition, it may not reach the maximum speed.

Note 3. The rated thrust and maximum transferable weight are values assuming the attached motor outputs the rated torque.

Note 4. When using in a clean environment, attach a suction air joint. The degree of cleanliness is the cleanliness level achieved when using at 1000 mm/sec or less.

Note 5. The required suction amount will vary according to the operating conditions and operating environment.

# TRANSEURO CLOSED LOOP STEPPING MOTOR SINGLE-AXIS ROBOTS

Type	Size (mm) <sup>Note 1</sup>	Model	Lead (mm)	Maximum payload(kg) <sup>Note 2</sup>		Maximum speed (mm/sec) <sup>Note 3</sup>	Stroke (mm)	
				Horizontal	Vertical			
					SR			SRD
SS type (Slide type) Inline model / Foldback model	W49 × H59	SS04-S SS04-R(L)	12	2	1	600	50 to 400	
			6	4	2	300		
			2	6	4	100		
	W55 × H56	SS05-S SS05-R(L)	20	4	-	1000	50 to 800	
			12	6	1	600		
			6	10	2	300		
	W55 × H56	SS05H-S SS05H-R(L)	20	6	-	1000	50 to 800	
			12	8	2	600 (Horizontal) 500 (Vertical)		
			6	12	4	300 (Horizontal) 250 (Vertical)		
SG type (Slide type)	W65 × H64	SG07	20	36	4	1200	50 to 800	
			12	43	12	800		
			6	46	20	350		
SR type (Rod type standard) Inline model / Foldback model	W48 × H56.5	SR03-S SR03-R(L) SR03-U	12	10	4	500	50 to 200	
			6	20	8	250		
			2	25	5	500		
	W48 × H58	SR04-S SRD04-R(L)	12	40	12	250	50 to 300	
			6	45	25	80		
			2	50	10	300		
	W56.4 × H71	SR05-S SRD05-R(L)	12	55	20	150	50 to 300	
			6	60	30	50		
			2	60	30	50		
SR type (Rod type with support guide) Inline model / Foldback model	W105 × H56.5	SRD03-S SRD03-U	12	10	3.5	500	50 to 200	
			6	20	7.5	250		
			12	25	4	500		
	W135 × H58	SRD04-S SRD04-U	6	40	11	250	50 to 300	
			2	45	24	80		
			12	50	8.5	300		
	W157 × H71	SRD05-S SRD05-U	6	55	18.5	150	50 to 300	
			2	60	28.5	50		
			5	6	2	200		
STH type (Slide type) Inline model/ Foldback model	W45 × H46	STH04-S	5	6	2	200	50 to 100	
	W73 × H51	STH04-R(L) <sup>Note 4</sup>	10	4	1	400		
	W61 × H65	STH06	8	9	2	150	50 to 150	
	W106 × H70	STH06-R(L)	16	6	4	400		

Type	High (mm)	Model	Torque type	Rotational torque (N/m)	Maximum pushing torque (N/m)	Maximum speed (mm/sec) <sup>Note 3</sup>	Rotation range (°)
STH type (Rotary type) Standard/High rigidity	42(Standard)	RF02-N RF02-S	N:Standard	0.22	0.11	420	310(RF02-N) 360(RF02-S)
	49(High rigidity)		H:High torque	0.32	0.16	280	
	53(Standard)	RF03-N RF03-S	N:Standard	0.8	0.4	420	320(RF03-N) 360(RF03-S)
	62(High rigidity)		H:High torque	1.2	0.6	280	
	68(Standard)	RF04-N RF04-S	N:Standard	6.6	3.3	420	320(RF04-N) 360(RF04-S)
	78(High rigidity)		H:High torque	10	5	280	

Type	Size (mm) <sup>Note 1</sup>	Model	Lead (mm)	Maximum payload (kg) <sup>Note 2</sup>		Maximum speed (mm/sec) <sup>Note 3</sup>	Stroke (mm)
				Horizontal	Vertical		
BD type (Belt type)	W40 × H40	BD04	48	1	-	1100	300 to 1000
	W58 × H48	BD05	48	5	-	1400	300 to 2000
	W70 × H60	BD07	48	14	-	1500	300 to 2000

Note 1. Size is the approximate cross sectional size.

Note 2. Maximum speed varies with the payload. See the SR type page for more details.

Note 3. Maximum speed decreases due to ball screw critical speed when the stroke is long. See the SR type page for more details.

Note 4. STH04-R (L) with 50st brake is not available.

■ Allowable ambient temperature for robot installation      SS/SR type: 0 to 40°C    STH/RF/BD type: 5 to 40°C

## FLIP - X SINGLE-AXIS ROBOTS

Type	Size (mm) <sup>Note 1</sup>	Model	Lead (mm)	Maximum payload (kg)		Maximum speed (mm/sec)	Stroke (mm)
				Horizontal	Vertical		
T type Compact model	W45 × H53	T4L/T4LH	12	4.5	1.2	720	50 to 400
			6	6	2.4	360	
			2	6	7.2	120	
	W55 × H52	T5L/T5LH	20	3	-	1200	50 to 800
			12	5	1.2	800	
			6	9	2.4	400	
	W65 × H56	T6L	20	10	-	1333	50 to 800
			12	12	4	800	
			6	30	8	400	
	W94 × H98	T9 (Standard)	30	15	-	1800	150 to 1050
			20	30	4	1200	
			10	55	10	600	
			5	80	20	300	
		T9H (High thrust)	30	25	-	1800	150 to 1050
			20	40	8	1200	
			10	80	20	600	
5			100	30	300		
F type High rigidity model	W80 × H65	F8	20	12	-	1200	150 to 800
			12	20	4	720	
			6	40	8	360	
	W80 × H65	F8L	30	7	-	1800	150 to 1050
			20	20	4	1200	
			10	40	8	600	
			5	50	16	300	
	W80 × H65	F8LH	20	30	-	1200	150 to 1050
			10	60	-	600	
			5	80	-	300	
	W110 × H71	F10	30	15	-	1800	150 to 1050
			20	20	4	1200	
			10	40	10	600	
			5	60	20	300	
		F10H (High thrust)	30	25	-	1800	150 to 1000
			20	40	8	1200	
			10	80	20	600	
			5	100	30	300	
	W136 × H83	F14 (Standard)	30	15	-	1800	150 to 1050
			20	30	4	1200	
			10	55	10	600	
			5	80	20	300	
		F14H (High thrust)	30	25	-	1800	
			20	40	8	1200	
			10	80	20	600	
			5	100	30	300	
	W168 × H100	F17L	50	50	10	2200	1100 to 2050
			40	40	-	2400	200 to 1450
		F17	20	80	15	1200	200 to 1250
			10	120	35	600	200 to 1450
W202 × H115	F20	40	60	-	2400	200 to 1450	
		20	120	25	1200	200 to 1250	
		10	-	45	600	200 to 1250	
W202 × H120	F20N	20	80	-	1200	1150 to 2050	
GF type High rigidity model	W145 × H91.5	GF14XL	20	45	-	1200	750 to 2000
	W168 × H105.5	GF17XL	20	90	-	1200	850 to 2500
N type Nut rotation model	W145 × H120	N15 (Single carriage)	20	50	-	1200	500 to 2000
		N15D (Double carriage)		250 to 1750			
	W180 × H115	N18 (Single carriage)		80	-		500 to 2500
		N18D (Double carriage)		250 to 2250			
B type Timing belt drive model	W100 × H81	B10	Belt drive	10	-	1875	150 to 2550
	W146 × H94	B14 (Standard)	Belt drive	20	-	1875	150 to 3050
		B14H (High thrust)	Belt drive	30	-	1875	
R type Rotation axis model	-	R5	-	0.12kgm <sup>2</sup>	-	360°/sec	360°
		R10		0.36kgm <sup>2</sup>	-		
		R20		1.83kgm <sup>2</sup>	-		

Note 1. Size is the approximate cross sectional size.

## Y P - X PICK & PLACE ROBOTS

Model	Axes	Structure				Maximum payload (kg)	Cycle time (sec)
		X axis	Y axis	Y axis	R axis		
YP220BX	2 axes	Belt	-	Belt	-	3	0.45
YP320X		Ball screw	-	Belt	-	3	0.57
YP220BXR	3 axes	Belt	-	Belt	Rotation axis	1	0.62
YP320XR		Ball screw	-	Belt	Rotation axis	1	0.67
YP330X		Ball screw	Ball screw	Belt	-	3	0.57
YP340X	4 axes	Ball screw	Ball screw	Belt	Rotation axis	1	0.67



## PHASER LINEAR MOTOR SINGLE-AXIS ROBOTS

Type	Size (mm) <sup>Note 1</sup>	Model	Carriage	Maximum payload (kg)	Maximum speed (mm/sec)	Stroke (mm)
MF type Steel cored linear motor with falt magnet	W85 × H80	MF7	Single	10 (7) <sup>Note 2</sup>	2500	100 to 4000(Horizontal) 100 to 2000(Wall mount)
		MF7D	Double			100 to 3800(Horizontal) 100 to 1800(Wall mount)
	W100 × H80	MF15	Single	30 (15) <sup>Note 2</sup>		100 to 4000(Horizontal) 100 to 2000(Wall mount)
		MF15D	Double			100 to 3800(Horizontal) 100 to 1800(Wall mount)
	W150 × H80	MF20	Single	40 (20) <sup>Note 2</sup>		150 to 4050
		MF20D	Double			150 to 3850
		MF30	Single	60 (30) <sup>Note 2</sup>		100 to 4000
		MF30D	Double			150 to 3750
	W210 × H100	MF75	Single	160 (75) <sup>Note 2</sup>		1000 to 4000
		MF75D	Double			680 to 3680

Note 1. Size is the approximate cross sectional size. Note 2. If using at maximum speed then the payload will be as shown in the ( ).

## XY-X CARTESIAN ROBOTS

Model	Arm variations					Number of axes	Maximum payload (kg)	Maximum stroke (mm)	
	Arm	Gantry	Moving arm	Pole	XZ			X axis	Y axis
PXYx	●	-	-	-	-	2 axes	4.5	150 to 650	50 to 300
FXYx	●	-	-	-	-	2 axes / 3 axes	12	150 to 1050	150 to 550
FXYBx	●	-	-	-	-	2 axes	7	150 to 2450	150 to 550
SXYx	●	-	●	●	●	2 axes / 3 axes / 4 axes	20	150 to 1050	150 to 650
SXYBx	●	-	-	-	●	2 axes / 3 axes / 4 axes	14	150 to 3050	150 to 550
MXYx	●	●	●	●	●	2 axes / 3 axes / 4 axes	30	250 to 1250	150 to 650
NXY	●	-	-	-	-	2 axes / 3 axes	25	500 to 2000	150 to 650
NXY-W	●	-	-	-	-	4 axes / 6 axes	25	250 to 1750	150 to 650
HXYx	●	●	●	●	●	2 axes / 3 axes / 4 axes	40	250 to 1250	250 to 650
HXYLx	●	●	-	-	-	2 axes	40	1150 to 2050	250 to 650

Note. The above maximum payloads are maximum stroke lengths are values when using arm type/cable carrier specifications.

## YRG ELECTRIC GRIPPER

Type	Model	Holding power (N)	Open/close stroke (mm)	Maximum speed (mm/sec)	Repeatability (mm)	Weight (g)
Compact single cam	YRG-2005SS	5	3.2	100	±0.02	90
Single cam	YRG-2010S	6	7.6	100	±0.02	160
	YRG-2815S	22	14.3	100	±0.02	300
Double cam	YRG-4225S	40	23.5	100	±0.02	580
	YRG-2005W	50	5	60	±0.03	200
	YRG-2810W	150	10	60	±0.03	350
Screw type Straight style	YRG-4220W	250	19.3	45	±0.03	800
	YRG-2020FS	50	19	50	±0.01	420
Screw type "T" style	YRG-2840FS	150	38	50	±0.01	880
	YRG-2020FT	50	19	50	±0.01	420
Three fingers	YRG-2840FT	150	38	50	±0.01	890
	YRG-2004T	2.5	3.5	100	±0.03	90
	YRG-2013T	2	13	100	±0.03	190
	YRG-2820T	10	20	100	±0.03	340
	YRG-4230T	20	30	100	±0.03	640

● Holding power control: 30 to 100% (1% steps)

● Speed control: 20 to 100% (1% steps)

● Acceleration control: 1 to 100% (1% steps)

● Multipoint position control: 10,000 max.

● Workpiece size judgment: 0.01 mm units (by ZON signal)

## YA Vertically articulated robots

Type	Model	Application	Number of axes	Payload (kg)	Vertical reach (mm)	Horizontal reach (mm)
6-axis	YA-RJ	Handling (general)	6-axis	1 kg (max. 2 kg*)	909	545
	YA-R3F			3	804	532
	YA-R5F			5	1193	706
	YA-R5LF			5	1560	895
	YA-R6F			6	2486	1422
7-axis	YA-U5F	Assembly / Placement	7-axis	5	1007	559
	YA-U10F			10	1203	720
	YA-U20F			20	1498	910

\* When a load is more than 1 kg, the motion range is reduced. Use the robot within the recommended motion range.

# YK-X/YK-XG/YK-XE/YK-TW/YK-XGS/YK-XGP SCARA ROBOTS

Model/Type		Model	Arm length (mm)	Maximum payload (kg)	Standard cycle time (sec) <sup>Note 1</sup>	
Completely beltless model	Extra small type	YK120XG	120	1.0	0.33	
		YK150XG	150			
		YK180XG	180			
	Small type	YK180X	180	5.0 (4.0) <sup>Note 3</sup>	0.49	
		YK220X	220			
		YK250XG	250			
Low cost high performance model		YK400XG	400	4.0 (3.0) <sup>Note 3</sup>	0.41	
Completely beltless model	Medium type	YK500XGL	500	5.0 (4.0) <sup>Note 3</sup>	0.59	
		YK500XG	500	10.0	0.45	
		YK600XGL	600	5.0 (4.0) <sup>Note 3</sup>	0.63	
		YK600XG	600	10.0	0.46	
		YK600XGH	600	20.0 (19.0) <sup>Note 3</sup>	0.47	
	Large type	YK700XGL	700	10.0 (9.0) <sup>Note 3</sup>	0.50	
		YK700XG	700	20.0 (19.0) <sup>Note 3</sup>	0.42	
		YK800XG	800		0.48	
		YK900XG	900		0.49	
		YK1000XG	1000		0.91	
-	YK1200X	1200	50.0		0.91	
Wall mount/inverse model		YK300XGS <sup>Note 2</sup>	300	5.0 (4.0) <sup>Note 3</sup>	0.49	
		YK400XGS <sup>Note 2</sup>	400			
		YK500XGS	500	10.0	0.45	
		YK600XGS	600			
		YK700XGS	700	20.0	0.42	
		YK800XGS	800			
		YK900XGS	900			
		YK1000XGS	1000			
Dust-proof & drip-proof model		YK250XGP	250	4.0	0.57	
		YK350XGP	350			
		YK400XGP	400	4.0	0.74	
		YK500XGLP	500			
		YK500XGP	500	10.0	0.55	
		YK600XGLP	600	4.0	0.74	
		YK600XGP	600	10.0	0.56	
		YK600XGHP	600	18.0	0.57	
		YK700XGP	700	20.0	0.52	
		YK800XGP	800			
		YK900XGP	900			
		YK1000XGP	1000			
	Orbit model		YK350TW	350	5.0	0.32
			YK500TW	500	5.0 (4.0) <sup>Note 3</sup>	0.29

Note 1. **Extra small type** Maximum payload: 0.1kg (100mm in the horizontal direction, 25mm-reciprocating in the vertical direction, coarse positioning)  
**Orbit type** Maximum payload: 1kg (300mm in the horizontal direction, 25mm-reciprocating in the reciprocating direction, coarse positioning)  
**Other type** Maximum payload: 2kg (300mm in the horizontal direction, 25mm-reciprocating in the reciprocating direction, coarse positioning)  
Note 2. The YK300XGS and YK400XGS are custom-order products. For details about the delivery time, please contact YAMAHA.  
Note 3. For the option specifications (tool flange mount type and user wiring/tubing through spline type), the maximum payload becomes the value in ( ).

## CLEANROOM SCARA ROBOTS

Type	Model	Arm length (mm)	Maximum payload (kg)	Standard cycle time (sec) <sup>Note</sup>	Beltless structure
Extra small type	YK180XC	180	1.0	0.42	○
	YK220XC	220	1.0	0.45	○
Small type	YK250XGC	250	4.0	0.57	○
	YK350XGC	350	4.0	0.57	○
	YK400XGC	400	4.0	0.57	○
Medium type	YK500XC	500	10.0	0.53	-
	YK500XGLC	500	4.0	0.74	○
	YK600XC	600	10.0	0.56	-
	YK600XGLC	600	4.0	0.74	○
Large type	YK700XC	700	20.0	0.57	-
	YK800XC	800	20.0	0.57	-
	YK1000XC	1000	20.0	0.60	-

Note. **Extra small type** Maximum payload: 0.1kg (100mm in the horizontal direction, 25mm-reciprocating in the vertical direction, coarse positioning)  
**Other type** Maximum payload: 2kg (300mm in the horizontal direction, 25mm-reciprocating in the reciprocating direction, coarse positioning)

## CLEANROOM SINGLE-AXIS ROBOTS

Type	Model	Size (mm) <sup>Note</sup>	Lead (mm)	Maximum payload (kg)		Maximum speed (mm/sec)	Stroke (mm)
				Horizontal	Vertical		
FLIP-XC type	C4L C4LH	W45xH55	12	4.5	1.2	720	50 to 400
			6	6	2.4	360	
			2	6	7.2	120	
	C5L C5LH	W55xH65	20	3	-	1000	50 to 800
			12	5	1.2	800	
			6	9	2.4	400	
	C6L	W65xH65	20	10	-	1000	50 to 800
			12	12	4	800	
			6	30	8	400	
	C8	W80xH75	20	12	-	1000	150 to 800
			12	20	4	720	
			6	40	8	360	
	C8L	W80xH75	20	20	4	1000	150 to 1050
			10	40	8	600	
			5	50	16	300	
	C8LH	W80xH75	20	30	-	1000	150 to 1050
			10	60	-	600	
			5	80	-	300	
	C10	W104xH85	20	20	4	1000	150 to 1050
			10	40	10	500	
5			60	20	250		
C14	W136xH96	20	30	4	1000	150 to 1050	
		10	55	10	500		
		5	80	20	250		
C14H	W136xH96	20	40	8	1000	150 to 1050	
		10	80	20	500		
		5	100	30	250		
C17	W168xH114	20	80	15	1000	250 to 1250	
		10	120	35	600		
C17L	W168xH114	50	50	10	1000	1150 to 2050	
		20	120	25	1000		
C20	W202xH117	10	-	45	500	250 to 1250	
		12	2	1	600		
SSC type (TRANSEURO)	SSC04	W49xH59	6	4	2	300	50 to 400
			2	6	4	100	
			20	4	-	1000	
	SSC05	W55xH56	12	6	1	600	50 to 800
			6	10	2	300	
			20	6	-	1000	
	SSC05H	W55xH56	12	8	2	600(Horizontal)/ 500(Vertical)	50 to 800
			6	12	4	300(Horizontal)/ 250(Vertical)	
			20	6	-	1000	

Note. Size is the approximate cross sectional size.

## CLEANROOM CARTESIAN ROBOTS

Type	Model	Axes	Moving range (mm)	Maximum speed (mm/sec)	Maximum payload (kg)
2 axes	SXYxC	X	150 to 1050mm	1000	20
		Y	150 to 650mm	1000	
3 axes	SXYxC (ZSC12)	X	150 to 1050mm	1000	3
		Y	150 to 650mm	1000	
		Z	150mm	1000	
	SXYxC (ZSC6)	X	150 to 1050mm	1000	5
		Y	150 to 650mm	1000	
		Z	150mm	500	
4 axes	SXYxC (ZRSC12)	X	150 to 1050mm	1000	3
		Y	150 to 650mm	1000	
		Z	150mm	1000	
		R	360°	1020°/sec	
	SXYxC (ZRSC6)	X	150 to 1050mm	1000	5
		Y	150 to 650mm	1000	
		Z	150mm	500	
		R	360°	1020°/sec	



---

**YRG, Inc.**

9101 Clubridge Drive, Fort Wayne, IN 46809  
**www.yrginc.com • (260) 747-3482**



**YAMAHA**

YAMAHA MOTOR CO., LTD.

**Robotics Operations FA Section**

127 Toyooka, Kita-ku, Hamamatsu, Shizuoka 433-8103, Japan  
Tel. +81-53-525-8350 Fax. +81-53-525-8378

**URL** <https://global.yamaha-motor.com/business/robot/>  
**E-mail** [robotn@yamaha-motor.co.jp](mailto:robotn@yamaha-motor.co.jp)

● Specifications and appearance are subject to change without prior notice.